

NORTH POLE TRIM & SUPPLIES LTD.

Product Reference Guide



Since 1979

North Pole Trim and Supplies Limited has been supplying interior finishing products to London and Southwestern Ontario since 1979. We aim to meet the needs of residential home builders, professional renovators, and do-it-yourself home owners. We also have a strong product line to support replacement window, insurance restoration, and apartment remodeling businesses. Our reputation has been built on delivering quality, value added products on time and on budget.

Our product lines include:

- huge selection of interior wood mouldings
- moulded hollow and solid interior doors
- wood raised or shaker panel interior doors
- interior decorative glass French doors
- rustic and contemporary barn door hardware
- fire rated doors
- finished plywood and dressed lumber
- interior and exterior wood tongue and groove, ship lap, and beaded wall and ceiling coverings
- custom made mirror or panel sliding closet doors
- ventilated wire shelving and wood closet shelving
- wood and decorative metal stair railing components
- Weiser, Baldwin, Emtek, Dorex, Taymor, and Aurum door hardware
- specialized hardware from KN Crowder, Onward, Richelieu, and Berenson
- fibre glass, PVC, or wood interior and exterior columns

In addition to the extensive product lines we have in stock, we also specialize in sourcing non-inventory, hard to find products for your special projects.

Our in-house custom pre-hanging and door machining shop is second-to-none. We can deliver custom orders quickly and with any special modifications needed for your project.

Our free delivery is extremely popular as most of our products are larger than your average vehicle. From Windsor to Owen Sound and from Sarnia to Guelph, our trucks will likely be in your area when you need us.

Our beautiful showroom is here to help you choose products and give you decorating ideas. Our experienced sales staff are there to help with product selections for your project. We also have outside sales staff to estimate your larger projects on site.

Come in and see what we have in store for you!

Yours truly,































Eric Toivonen, President

TABLE OF CONTENTS

Finger Joint Pine Profiles (Primed & Raw)	2-3
Primed MDF Profiles	4-6
Poplar Profiles	7-9
Maple Profiles	10
Oak Profiles	11-13
Clear Pine Profiles	14-15
Mahogany Profiles	16
Dressed Four Sides	17
Stair Railing Components	18
Interior Doors	19
Location	Back Cover

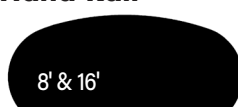



























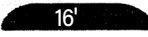

PRIMED & RAW FINGER JOINT PINE PROFILES

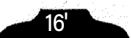
MOULDING PROFILE	STOCK #	SIZE IN INCHES	MOULDING PROFILE	STOCK #	SIZE IN INCHES
Bevel Casings			Baseboards		
14' 	§ C110	3/8 X 2 1/8		° B622	5/16 X 3 1/8
14' 	§ C111	7/16 X 2 1/2		§ B602	7/16 X 3 1/2
Plain Baseboards				§ B604	7/16 X 4 1/8
16' 	§ B130	5/16 X 3 3/8		° B623	1/2 X 3 3/4
16' 	§ B131	5/16 X 4 1/8		§ B608	3/8 X 4 1/8
Door & Window Casings				† 1516	7/16 X 4 1/8
14' 	° C621	3/8 X 2 1/8		§ B3506	2 1/32 X 4 1/4
14' 	§ C603	9/16 X 2 1/2		° B706	9/16 X 4 1/8
14' 	† C705	5/8 X 2 3/4		° 3518	7/16 X 5 1/4
14' 	§ C715	3/4 X 3 1/8		° BAC154A	1 1/16 X 1 5/16
15' 	§ 4642	1 1/16 X 3		BAS400	5/8 X 4 1/4
14' 	§ C3505	5/8 X 2 3/4		BAS503	5/8 X 5 1/4
16' 	° C8200	3/4 X 3 1/2	Wall & Ceiling		
Door Jams				° S1056	1/2 X 7 5/16
7' & 8' 	† J458	1 1/16 X 4 5/8	Hand Rail		
7' & 8' 	° J658	1 1/16 X 6 5/8		§ M191	1 7/16 X 2 3/8
7' pcs only 	§ J4916	1 1/4 X 4 9/16			
7' pcs only 	§ J6916	1 1/4 X 4 9/16			

Products on this page are sold in full or half lengths. † Primed & Raw ° Primed Only § Raw Only

Profiles are approximately 50% of actual size





























PRIMED & RAW FINGER JOINT PINE PROFILES

MOULDING PROFILE	STOCK #	SIZE IN INCHES	MOULDING PROFILE	STOCK #	SIZE IN INCHES
Door Steps			Ply Cap		
 14'	§ M70	5/16 X 1 1/16	 16'	§ M614	1 3/16 X 1 5/8
 14'	† M73	7/16 X 1 3/16			
Shoe Mould			Lattice		
 16'	† M101	7/16 X 1 1/16	 7'	§ M012	5/16 X 1 1/16
 14'	ø M3862	7/16 X 1 1/16	 8'	§ M0158	5/16 X 1 1/16
Quarter Rounds			Shingle Mouldings		
 16'	§ M100	7/16 X 7/16	 8'	§ M187	1/2 X 3/4
 16'	† M102	1 1/16 X 1 1/16	 16'	ø M188	9/16 X 1 1/8
 16'	§ M103	1 5/16 X 1 5/16	 16'	§ M189	9/16 X 1 1/2
Cove Mouldings			Crown Mouldings		
 16'	§ M105	1/2 X 1/2	 16'	§ M173	7/16 X 1 5/8
 16'	† M106	1 1/16 X 1 1/16	 16'	§ M179	9/16 X 3 1/8
 16'	§ M107	1 5/16 X 1 5/16	 16'	§ M180	9/16 X 4 1/2
Burlap Mouldings			Outside Corners		
 16'	ø M166	5/16 X 1 3/16	 8'	§ M170	3/4 X 3/4
 16'	§ M168	5/16 X 1 1 1/16	 16'	§ M171	1 X 1
 16'	§ M163	5/16 X 1 3/16	Chair Railings		
Brick Mould			 16'	§ M689	1 1/16 X 1 3/4
 16'	§ M535	1 1/4 X 2	 16'	§ M690	1 1/16 X 2 1/2
 7'	M350	1 1/8 X 1 5/8	Decorative Mouldings		
			 16'	§ M695	5/16 X 3/4
			 16'	§ M696	9/16 X 1 1/8
			 8'	§ M0818	5/16 X 5/8
			Screen Mould		
			 8'	§ M0908	1/4 X 3/4

Products on this page are sold in full or half lengths. † Primed & Raw ø Primed Only § Raw Only

Profiles are approximately 50% of actual size

PRIMED MDF PROFILES

MOULDING PROFILE	STOCK #	SIZE IN INCHES	MOULDING PROFILE	STOCK #	SIZE IN INCHES
Casings			Casings continued		
	9-5357	1/2 x 2 1/4		9-5729	5/8 x 3 3/8
	9-7705	5/8 x 2 3/4		9-693	3/4 x 4 7/8
	9-411	3/4 x 3		9-5642	1 x 3
	9-954	3/4 x 3 1/2		9-1113	3/4 x 3 1/2
	9-535	3/4 x 3 1/2		9-1743	3/4 x 2 3/4
	9-CR670	3/4 x 3 1/2		9-1737	3/4 x 3 1/2
	9-8063	3/4 x 3 1/4		9-100	1/2 x 2 3/4
	9-3357	1 1/4 x 4		9-200	1 1/16 x 3 1/4
	9-8044	1 1/8 x 3 1/2		9-325	3/4 x 3 1/4
	9-7719	5/8 x 2 3/4		9-2189	5/8 x 3 1/2
	9-7736	3/4 x 3 1/2		9-2189A	5/8 x 2 3/4
	9-7776	3/4 x 3 1/2		9-9090	5/8 x 3
	9-977	3/4 x 3		9-9091	5/8 x 3 1/2
	9-5977	3/4 x 3 3/8	Back Band		
				9-003	7/8 x 1 5/16



























PRIMED MDF PROFILES

MOULDING PROFILE	STOCK #	SIZE IN INCHES	MOULDING PROFILE	STOCK #	SIZE IN INCHES
Baseboards			Baseboards continued		
	9-7622	3/8 x 3 3/8		9-976	5/8 x 6 1/2
	9-5706A	3/8 x 3 7/8		9-612	5/8 x 6 1/2
	9-7706	1/2 x 4 1/8		9-5955	5/8 x 5 5/16
	9-412	5/8 x 4 1/4		9-101	3/8 x 4 1/4
	9-7711	1/2 x 5 1/4		9-201	1/2 x 5 1/4
	9-8915	1/2 x 7 1/4		9-CR678	5/8 x 5 1/4
	9-3709	5/8 x 7		9-239	5/8 x 5 1/2
	9-545	5/8 x 5		9-1969	1/2 x 4 1/2
	9-7720	3/8 x 3 7/8		9-3533	5/8 x 5 1/2
	9-5739	1/2 x 5 1/2		9-8239	5/8 x 7 1/4
	9-5737	5/8 x 5 1/2		9-2190	1/2 x 5 1/4
	9-8235	5/8 x 7 1/4		9-2190A	1/2 x 4 3/4
				9-9290	1/2 x 5
				9-9291	1/2 x 6 1/2

Products on this page are sold in full or half lengths.

*Profiles are approximately
50% of actual size*



















PRIMED MDF PROFILES

MOULDING PROFILE	STOCK #	SIZE IN INCHES	MOULDING PROFILE	STOCK #	SIZE IN INCHES
Jamb			Chair Rail		
7' & 8' Beveled 	J458	5/8 x 4 5/8	8' 	9-5689	5/8 x 1 3/4
7' & 8' Beveled 	J658	5/8 x 6 5/8	14' 	9-5741	5/8 x 2 1/2
Door Stop			Crown Moulding		
14' 	9-3057	3/8 x 1 1/4	14' 	9-5981	3 5/16
14' 	9-1698	3/8 x 1 3/8	16' 	9-5180	4 1/8
14' 	9-2438	3/8 x 1 3/16	14' 	9-5982	4 1/2
14' 	9-3680A	3/8 x 1 1/4	14' 	9-5980	5 1/4
	9-1698A	3/8 x 1	14' 	9-712	4 1/2
Wall & Ceiling			16' 	9-699	5 15/16
	9-WAINT&G	3/8 x 7 x 96 3/pkg	16' 	9-41	6 5/16
16' 	16MIDFT&G	5/8 x 5 1/2	16' 	9-900	1 3/16 x 5 1/4
Shiplap			12' 	9-901	1 3/16 x 6 3/4
16' 	9-1056A	1/2 x 5 5/16	16' 	9-2192A	19/32 x 4 1/2
16' 	9-1056	1/2 x 7 5/16			
Architrave					
8' 	9-5000	1 3/16 x 3 3/4			
12' 	9-5020	1 3/16 x 5 1/4			
12' 	9-519	1 1/2 x 6 1/2			
16' 	9-2193A	7/8 x 4 1/2			

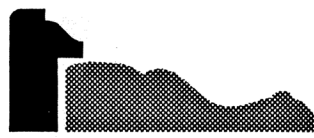





















Products on this page are sold in full or half lengths.

Profiles are approximately 50% of actual size

























POPLAR PROFILES

MOULDING PROFILE	STOCK #	SIZE IN INCHES	MOULDING PROFILE	STOCK #	SIZE IN INCHES
Bevel Casings			Colonial Baseboard		
	CAS214	3/4 x 2 1/2		BAS400	5/8 x 4 1/4
	CAS302	3/4 x 3 1/2		BAS503	5/8 x 5 1/4
Colonial Casing				BAS704	1 1/16 x 7 1/4
	CAS255	3/4 x 2 3/4	Baseboard		
	CAS314	3/4 x 3 1/4		BAS508	5/8 x 5 1/4
Step Casing				BAS712	1 1/16 x 7 1/4
	CAS219	3/4 x 2 3/4		BAS206	1 1/16 x 5 1/2
	CAS300	3/4 x 3 1/4	Step Baseboard		
Back Band (Casing Enhancer)				BAS412	5/8 x 4 1/4
	BAC102	3/4 x 1 1/4		BAS509	5/8 x 5 1/4
	BA C083	1 3/16 x 1 5/16		BAS701	1 1/16 x 7 1/4
			Modern Casings		
				CAS311	3/4 x 3 1/4
			Modern Baseboards		
				BAS511	5/8 x 5 1/4













POPLAR PROFILES

MOULDING PROFILE	STOCK #	SIZE IN INCHES	MOULDING PROFILE	STOCK #	SIZE IN INCHES
Crown & Cove Moulding			Door Jamb		
	COV009	3/4 x 2 3/8		JAM1X5	3/4 x 4 5/8
	BED201	3/4 x 2 1/2		JAM1X7	3/4 x 6 5/8
	CRO302	3/4 x 3 3/8	Door Stops		
	CRO300	3/4 x 3 1/2		STO100	5/16 x 1 1/4
	CRO400	1 1/16 x 4 1/4		STO102	1/2 x 1 1/2
	COV414	3/4 x 4 1/4		STO174	1/2 x 1 1/2
	CRO500	1 1/16 x 5 1/4	Colonial Shoe		
	CRO702	3/4 x 7 1/4		SHI002	1/2 x 3/4
Base Cap				SHI003	1/2 x 3/4
	BAS100	3/4 x 1 1/2	Chair Rail		
	CAP300	3/4 x 3		CHA038	1 1/16 x 3 1/2
				CHA110	5/8 x 1 5/8
				M214	1 1/16 x 2 1/4
			 3/8" Offset	CAP100	1 3/16 x 1 1/8
			Glass Stop		
				STO103	1 1/16 x 1





















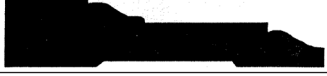

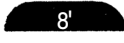

POPLAR PROFILES

MOULDING PROFILE	STOCK #	SIZE IN INCHES	MOULDING PROFILE	STOCK #	SIZE IN INCHES
Inset Panel Mould			Window Sill		
 1/4" Offset	PAN001	9/16 x 7/8		SIL203	3/4 x 2 1/2
 1/2" Offset	PAN101	1 3/16 x 1 3/8		SIL502	3/4 x 5 1/2
 3/4" Offset	PAN103	1 3/16 x 1 5/8		SIL306	1 1/4 x 3 1/2
 1/2" Offset	PAN005	1 1/16 x 1 1/16			
Cove Mould				SIL503	1 1/4 x 5 1/2
	COV003	3/4 x 3/4	Header Moulding	CAP200	1 3/8 x 2 1/4
	COV004	1 3/16 x 1 3/16			
	QUA009	3/4 x 3/4			
Decorative Panel Mould				ARC401	1 3/8 x 4 5/8
	DEC007	1/2 x 7/8	Outside Corner	OUT105	5/16 x 1 1/4
	DEC103	7/16 x 1 1/16			
	DEC105	3/4 x 1 5/8			
	PRO104	7/16 x 1 1/4			
	BUR114	3/8 x 1 1/4			
	HAL001	3/8 x 3/4			
	HAL101	5/8 x 1 1/4			
	DEC036	5/8 x 7/8			
	M135	5/8 x 1 1/4			
	SHI101	3/4 x 1 5/8	Bead Mould	BEA38	3/8 x 1 1/8
				BEA100	1/2 x 1
					
			Nosing	NOS401	1 1/16 x 4 3/4
			 3/4" Tail		



















MAPLE PROFILES

MOULDING PROFILE	STOCK #	SIZE IN INCHES	MOULDING PROFILE	STOCK #	SIZE IN INCHES
Colonial Casing 	CAS255	3/4 x 2 3/4	Chair Rail 	CHA110	5/8 x 1 5/8
Colonial Baseboard 	BAS400	5/8 x 4 1/4	Burlap Mouldings 	BUR102	5/16 x 1 5/8
Colonial Shoe 	SHI002	1/2 x 3/4		BUR114	3/8 x 1 1/4
Crown & Cove Moulding 	CRO302	1 1/16 x 3 3/4	Quarter Rounds 	QUA009	3/4 x 3/4
	CRO400	1 1/16 x 4 1/4	Nosing 	NOS400	1 1/16 x 4 1/4
	COV003	3/4 x 3/4	5/16" Tail		
	COV004	1 3/16 x 1 3/16		NOS401	1 1/16 x 4 1/4
Inset Panel Mould  1/2" Offset	PAN101	1 3/16 x 1 3/8	3/4" Tail		
 1/2" Offset	PAN005	1 1/16 x 1 1/16		NOS504	1 1/16 x 5
Decorative Panel Mould 	DEC007	1/2 x 7/8	Reducer 	RED116	1/2 x 1 3/4
				RED114	1/2 x 1 7/16
				RED202	3/4 x 2 1/4









OAK PROFILES

MOULDING PROFILE	STOCK #	SIZE IN INCHES	MOULDING PROFILE	STOCK #	SIZE IN INCHES
Colonial Casings			Colonial Baseboards		
	C222	7/16 x 2 1/4		BAS300	5/16 x 3 1/4
	1207	5/8 x 2 1/2		1215	7/16 x 4 1/8
	CAS255	3/4 x 2 3/4		BAS400	5/8 x 4 1/4
	CAS314	3/4 x 3 1/4		BAS503	5/8 x 5 1/4
Step Casings			Door Jamb (Oak Veneer)		
	CAS219	3/4 x 2 3/4		J458V	5/8 x 4 9/16
	CAS300	3/4 x 3 1/4	Door Jamb (Solid Oak)		
Back Band (Casing Enhancer)				JAM1X5	3/4 x 4 5/8
	BAC102	3/4 x 1 1/4	Door Stops		
Step Baseboards				STO100	5/16 x 1 1/4
	BAS509	5/8 x 5 1/4		STO102	1/2 x 1 1/2
			Burlap Mouldings		
				M9668	5/16 x 1 1/4
				BUR101	5/16 x 1 1/4
				BUR102	5/16 x 1 5/8
				BUR114	3/8 x 1 1/4
			Shoe Mould		
				SHO001	1/2 x 3/4
			Quarter Rounds		
				QUA006	1/2 x 1/2
				QUA009	3/4 x 3/4
			Colonial Shoe Mould		
				SHI002	1/2 x 3/4
				SHI003	1/2 x 3/4





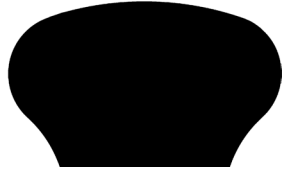













OAK PROFILES

MOULDING PROFILE	STOCK #	SIZE IN INCHES	MOULDING PROFILE	STOCK #	SIZE IN INCHES
Cove Mouldings					
 8'	M9058	1/2 x 1/2	Chair Rail		
	COV003	3/4 x 3/4		CHA204	1 3/16 x 2 1/2
	COV004	1 3/16 x 1 3/16	Inset Panel Mould		
Outside Corners			 3/4" Offset	PAN103	1 3/16 x 1 5/8
 8'	M9708	1 1/16 x 1 1/16	Decorative Panel Mould		
 8'	M9718	1 x 1		DEC103	7/16 x 1 1/16
	OUT138	1/2 x 1 3/8		PRO104	7/16 x 1 1/4
Ceiling Crowns & Coves				M135	5/8 x 1 1/4
 8'	M9738	1 1/16 x 1 9/16		M9958	5/16 x 3/4
	BED201	3/4 x 2 1/2			
	CRO302	1 1/16 x 3 1/4			
	CRO400	1 1/16 x 4 1/4			
Shingle Mould					
 8'	M9888	9/16 x 1 1/8			
	SHI101	3/4 x 1 5/8			

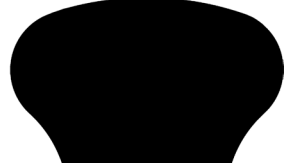



OAK PROFILES

MOULDING PROFILE	STOCK #	SIZE IN INCHES	MOULDING PROFILE	STOCK #	SIZE IN INCHES
Nosing  5/16" Tail	NOS400	1 1/16 x 4 1/2	Reducer 	RED202	3/4 x 2 1/4
 3/4" Tail	NOS401	1 1/16 x 4 1/2		RED116	1/2 x 1 3/4
 3/4" Tail	NOS504	1 1/16 x 5		RED114	1/2 x 1 7/16
Bar Rail 	BAR301	1 1/4 x 3 5/8	Hand Rail 	HAN200	1 1/4 x 2 1/2
	BAR501	1 3/4 x 5 1/4			











CLEAR PINE PROFILES

MOULDING PROFILE	STOCK #	SIZE IN INCHES	MOULDING PROFILE	STOCK #	SIZE IN INCHES
Casings			Quarter Rounds		
	CAS214	3/4 x 2 1/2	 8'	M0998	1/4 x 1/4
	C705	5/8 x 2 3/4		M102	1 1/16 x 1 1/16
	CAS255	3/4 x 2 3/4	 8'	M1038	1 5/16 x 1 5/16
	CAS314	3/4 x 3 1/4	Shoe Mould		
				M101	7/16 x 1 1/16
			Cove Mouldings		
Baseboards			 8'	M1058	1/2 x 1/2
	B604	7/16 x 4 1/8		M106	1 1/16 x 1 1/16
	B608	7/16 x 4 1/8	Hand Rail		
	BAS400	5/8 x 4 1/4		M191	1 1/4 x 2 3/8
	BAS503	5/8 x 5 1/4	Shingle Mouldings		
	BAS508	5/8 x 5 1/4	 8'	M1878	1/2 x 3/4
Door Jamb					
	JAM1X5	3/4 x 4 5/8			
Door Stops					
 7'	M070	5/16 x 1 1/16			
	STO100	5/16 x 1 1/4			

CLEAR PINE PROFILES

MOULDING PROFILE	STOCK #	SIZE IN INCHES	MOULDING PROFILE	STOCK #	SIZE IN INCHES
Crown Mouldings					
	M1748	7/16 X 2 1/8			
	M179	9/16 X 3 1/8			
Chair Railings					
	M689	9/16 X 1 3/4			
	M698	1 5/16 X 2 3/8			
Decorative Mouldings					
	M6968	9/16 X 1 1/8			

MAHOGANY PROFILES

MOULDING PROFILE	STOCK #	SIZE IN INCHES	MOULDING PROFILE	STOCK #	SIZE IN INCHES
Bevel Casing 	C110	3/8 x 2 1/8	Shoe Mould 	M101	7/16 x 1 1/16
Colonial Door & Window Casings 	C563	9/16 x 2 3/4	Quarter Rounds 	M1008	1/2 x 1/2
	CAS255	3/4 x 2 3/4		M102	1 1/16 x 1 1/16
Colonial Baseboards 	B618	5/16 x 3	Cove Mouldings 	M106	1 1/16 x 1 1/16
Door Jamb 	J458	5/8 x 4 5/8			
Door Stops 	M707	5/16 x 1 1/16			
	M737	3/8 x 1 3/16			

DIMENSION	FJ. PINE	PRIMED FJ. PINE	MDF	CLEAR PINE	KNOTTY PINE	MAHOGANY	POPLAR	OAK	MAPLE	CHERRY	CLEAR CEDAR
3/8 X 1-5/16							■	■	■		
3/8 X 1-3/4							■	■	■		
1/2 X 7/8							■	■	■		
1/2 X 1-5/8							■	■			
1/2 X 2-1/2							■	■	■		
1/2 X 3-1/2							■				
3/4 X 1-1/2		16' ■		■	■		■	■	■		
3/4 X 2-1/2		16' ■	16' ■ 5/8THICK	■	■		■	■	■		
3/4 X 3-1/2		16' ■	16' ■ 5/8THICK	■	■		■	■	■		
3/4 X 4-1/2		16' ■									
3/4 X 5-1/2	16' ■	16' ■	16' ■ 5/8THICK	■	■	■	■	■	■	■	■
3/4 X 7-1/4	16' ■	16' ■	16' ■ 5/8THICK	■	■	■	■	■	■	■	■
3/4 X 9-1/4		16' ■		■	■	■	■	■	■		
3/4 X 11-1/4		16' ■		■	■	■	■	■			
1-1/4 X 4-5/8							■				
1-1/4 X 5-1/2							■	■			
1-1/4 X 6-5/8							■				
1-1/4 X 7-1/4							■	■	■		
1-1/4 X 9-1/4							■				
2X 2	16' ■ 1-5/8x1-5/8										
2X 4	16' ■ 1-5/8x3-1/2			■ 1-3/8x3-1/2	■ 1-3/4x3-1/2		■ 1-5/8x3-1/2	■ 1-5/8x3-1/2	■ 1-5/8x3-1/2		■
2X 6				■ 1-3/8x5-1/2	■ 1-3/4x5-1/2		■ 1-5/8x5-1/2	■ 1-5/8x5-1/2	■ 1-5/8x5-1/2		■
2X 8				■ 1-3/8x7-1/4	■ 1-3/4x7-1/4		■ 1-5/8x7-1/4	■ 1-5/8x7-1/4	■ 1-5/8x7-1/4		■
2X 10					■ 1-3/4x9-1/4			■ 1-5/8x9-1/4			■
2X 12				■ 1-3/8x11-1/4	■ 1-3/4x11-1/4			■ 1-5/8x11-1/4			■



FJ. and MDF are sold in full or half lengths

Solid wood is sold in random lengths.

STAIR RAILING COMPONENTS

Hand Rail

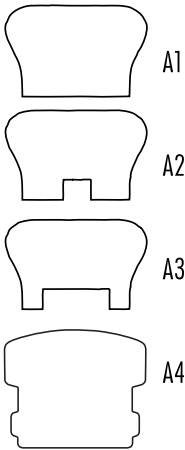

A1 - HR	1 3/4 x 2 3/4 NO Groove
A2 - HRGMR	1 3/4 x 2 3/4 1/2 Groove
A3 - HRG	1 3/4 x 2 3/4 1 5/16 Groove
A4 - MR	2 x 2 7/16

Oak, Poplar, Maple Bottom Rail

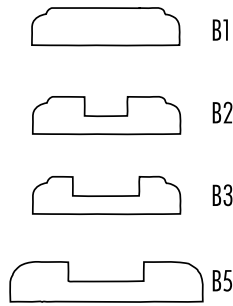

B1 - BRNG	3/4 x 2 7/8 NO Groove
B2 - BRMR	3/4 x 2 7/8 3/4 Groove
B3 - BR1516	3/4 x 2 7/8 1 5/16 Groove
B5 - BRSPEC	3/4 x 3 1/2 1 5/16 Groove

Fillers

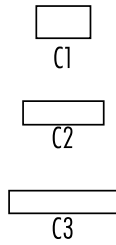

C1 - FMR	1/2 x 7/8
C2 - F1516	3/8 x 1 5/16
C3 - F175	3/8 x 1 3/4

Decorative Metal Spindles

We stock a large selection of steel stair spindles in various finishes from Bezdán.
www.geobezdán.com

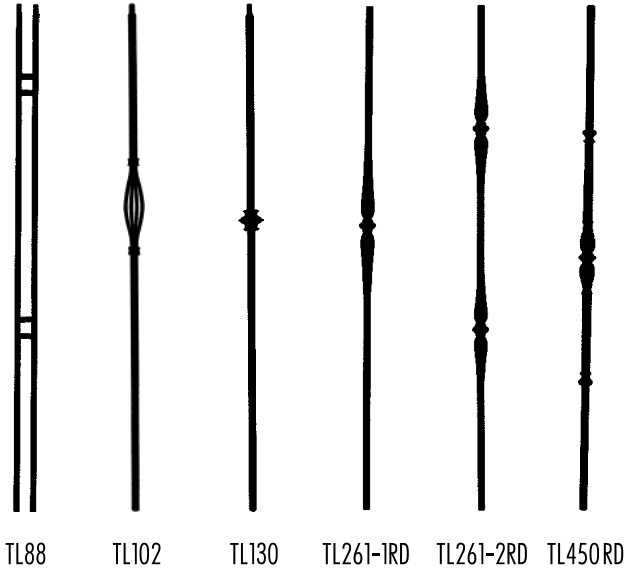

Heritage Series - Oak, Poplar, Maple

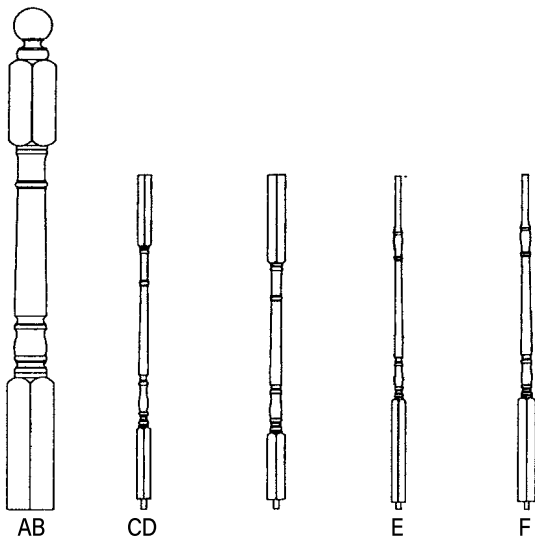

A - Newel Posts	3 1/2 x 48	3 1/2 x 55		
C - Square Top Spindles	1 5/16 x 34	1 5/16 x 38		
E - Dowel Top Spindles	1 5/16 x 34	1 5/16 x 36	1 5/16 x 38	1 5/16 x 42

Contemporary Series - Oak, Poplar, Maple

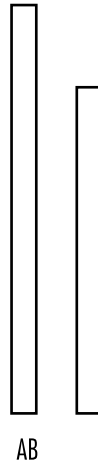

A - Newel Posts	3 1/2 x 52
B - Square Top Ballusters	1 5/16 x 34 1 5/16 x 38 1 5/16 x 42

INTERIOR DOORS

Embossed Doors

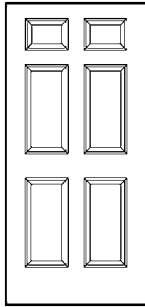

Colonist
Textured

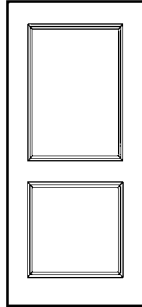

Cambridge
Smooth

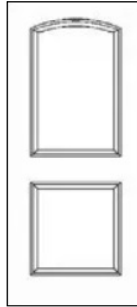

Roman
Smooth



Riverside
Smooth

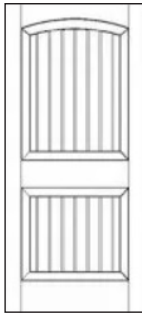

Cheyenne
Smooth



Conmore
Smooth

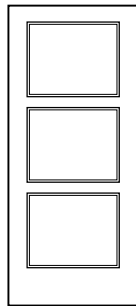

Birkdale
Smooth

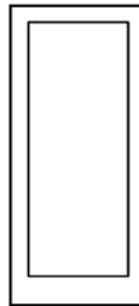

Madison
Smooth

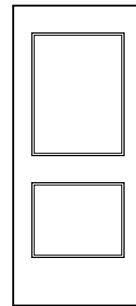

Monroe
Smooth

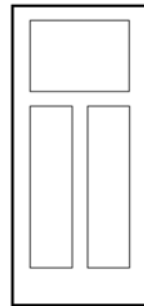

Craftsman
Smooth



Berkley
Smooth



Melrose
Smooth



Hardboard
Smooth

Large Selection of French Doors



Pantry



DWL



Plain French



Custom Mirror Doors and Panels

Many other styles are available and can be viewed in our showroom.

SHELVING PROGRAM

Good - Wire

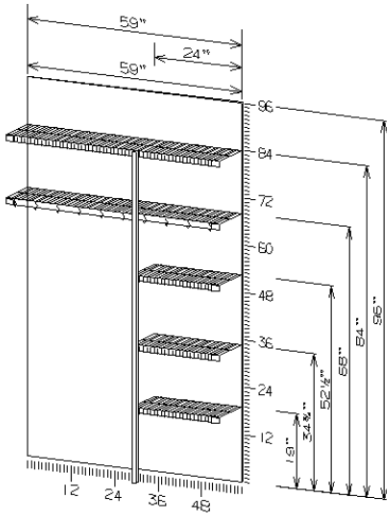

Better - freedomrail

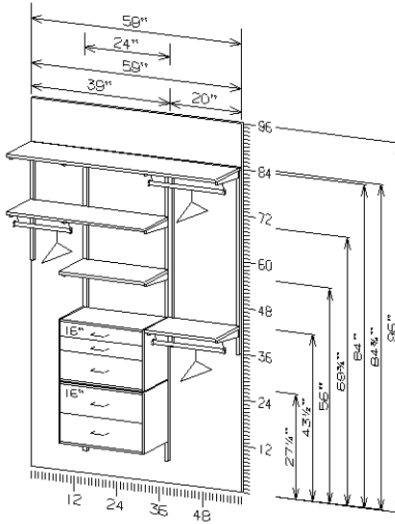

Even Better - Classica:
Wall Mounted

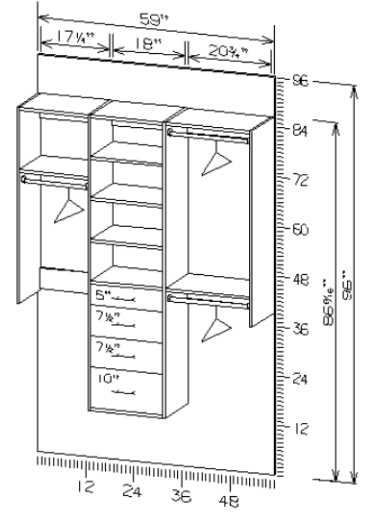

Best - Classica:
Floor Mount

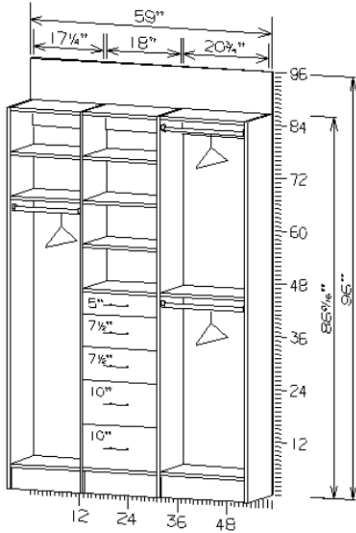

All layouts are custom designed and priced accordingly. Ventilated wire includes cut to size by North Pole Trim. Cut to size is available for freedomRail and Classica. Install available for all shelving (within 2 hours from London)

Options available for ventilated wire:

In stock:

White finish in:

Shelf & Rod: 12" D & 16" D Linen Shelf: 12" D, 16" D, & 20" D

Open Slide: 12" D & 16" D Closed Mesh: 9" D, 12" D, & 16" D

Special Order: Nickel finish (75 LF minimum order)

For more information, contact our in house Organized Living Specialist



Shelf & Rod



Open Slide



Closed Mesh



Linen Shelf



Metal
Corner
Bracket



Versa Clips



Side Wall
Brackets



Tri Lock
Anchors/
Screws

NOTES & SKETCHES

SOUTHWESTERN ONTARIO'S LARGEST IN-STOCK DOOR HARDWARE SELECTION

**Weiser - Baldwin - Schlage - Dorex
Emtek - Onward - KN Crowder
Berenson - Taymor**

CLOSET SHELVING FROM ORGANIZED LIVING

**Ventilated Wire Shelving - cut to size
Adjustable "Freedom Rail" System
"Classica" Wood Shelving**

LOCATION

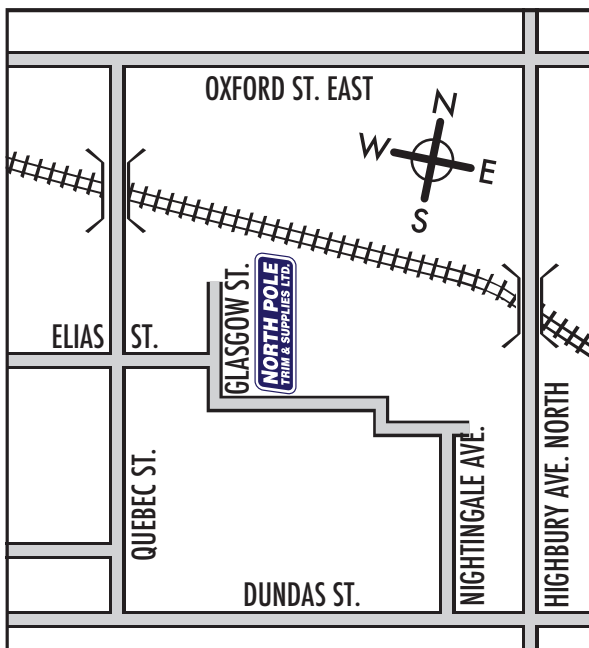

Your interior finishing specialists.

560 Glasgow Street, London, ON N5W 4A3

Bus: 519-434-3251 • Toll Free: 1-800-363-3251 • Fax: 519-434-4125

Web: www.northpoletrim.com • Email: sales@northpoletrim.com